

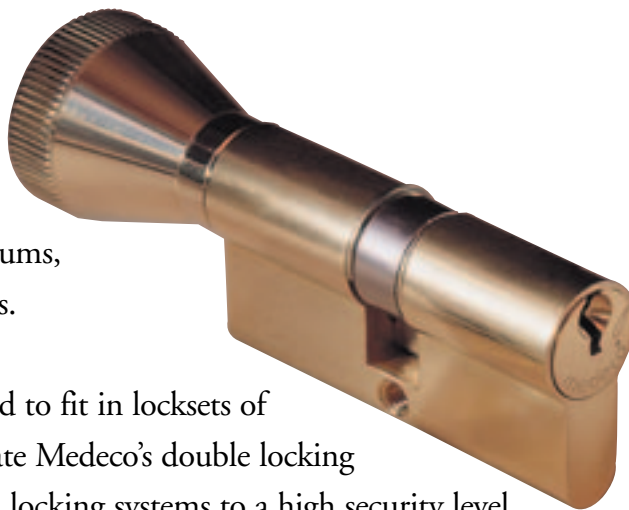

International Cylinders

Medeco provides high security locking cylinders in six continents. Our products protect facilities worldwide such as high security government installations, industrial and institutional organizations, airports, hotels, power plants, palaces, museums, universities and schools, and office buildings.



Medeco's international cylinders are designed to fit in locksets of major world manufacturers. They incorporate Medeco's double locking principle, and are used to upgrade common locking systems to a high security level. They include the pick resistant, drill resistant and wrench resistant features of the UL Listed Medeco cylinders, as well as restricted patented key control. Medeco's international cylinders are available in all pinning technologies (Original, Biaxial, BiLevel), all finishes, and all keyways.

In addition to certification through UL, Medeco tests for certification from the following international bodies:



Svensk Standard
SS 3522



Israeli Standards
I.S 950



EUROPEAN COMMITTEE FOR STANDARDIZATION
COMITE EUROPEEN DE NORMALISATION
EUROPAISCHES KOMITEE FUR NORMUNG

Other International Cylinders

Medeco manufactures thousands of specialty cylinders for unique applications across the world including retrofits for international door hardware, OEM applications, and industrial locks. Included in this section are some of the most commonly encountered international designs.



International Cylinders

Benefits:

- ▼ Double locking principle provides pick resistance and large numbers of combinations for master keying flexibility.
- ▼ Utility patented key control provides protection from unauthorized duplication of keys.
- ▼ Hardened steel inserts in the cylinder face provide proven drill resistance.
- ▼ Solid brass construction provides high quality and long cylinder life; standard finishes compliment existing hardware.
- ▼ UL 437 Listing provides validation of high security from a recognized, quality testing group.
- ▼ Precision design and manufacture of custom cylinder shapes for virtually any industrial or door application.
- ▼ Multiple patented key technologies available.
- ▼ Special key machine required to cut precision angled cuts and offset cut positions.

Warranty:

Warranted for two years against manufacturer's defects.
(See Medeco® Limited Warranty for full details)

Certification:

UL 437 Listed; VDS Class B; Israeli Standards I.S. 950;
Swedish Standards SS 3522; CEN 1303.

Technical Information:

#8-32 pin chamber set screws provide ease of rekeying and add strength to resist forced attacks.

Finishes:

All standard finishes available.

Euro-Profile (23-13 Series)

Ordering Information

Medeco's profile cylinders interchange with cylinders conforming to DIN 18254. They are available in 5 Pin or 6 Pin lengths, single cylinder with thumbturn, double cylinders or half cylinder. They can be ordered in a variety of cams, finishes or keyways, and they are available in length extensions of 5mm up to the total of 45mm on either side. Longer extensions may be available upon special order.

Complete part numbers are required for all orders. To determine the correct part number, fill in the "X's" in sequential order.

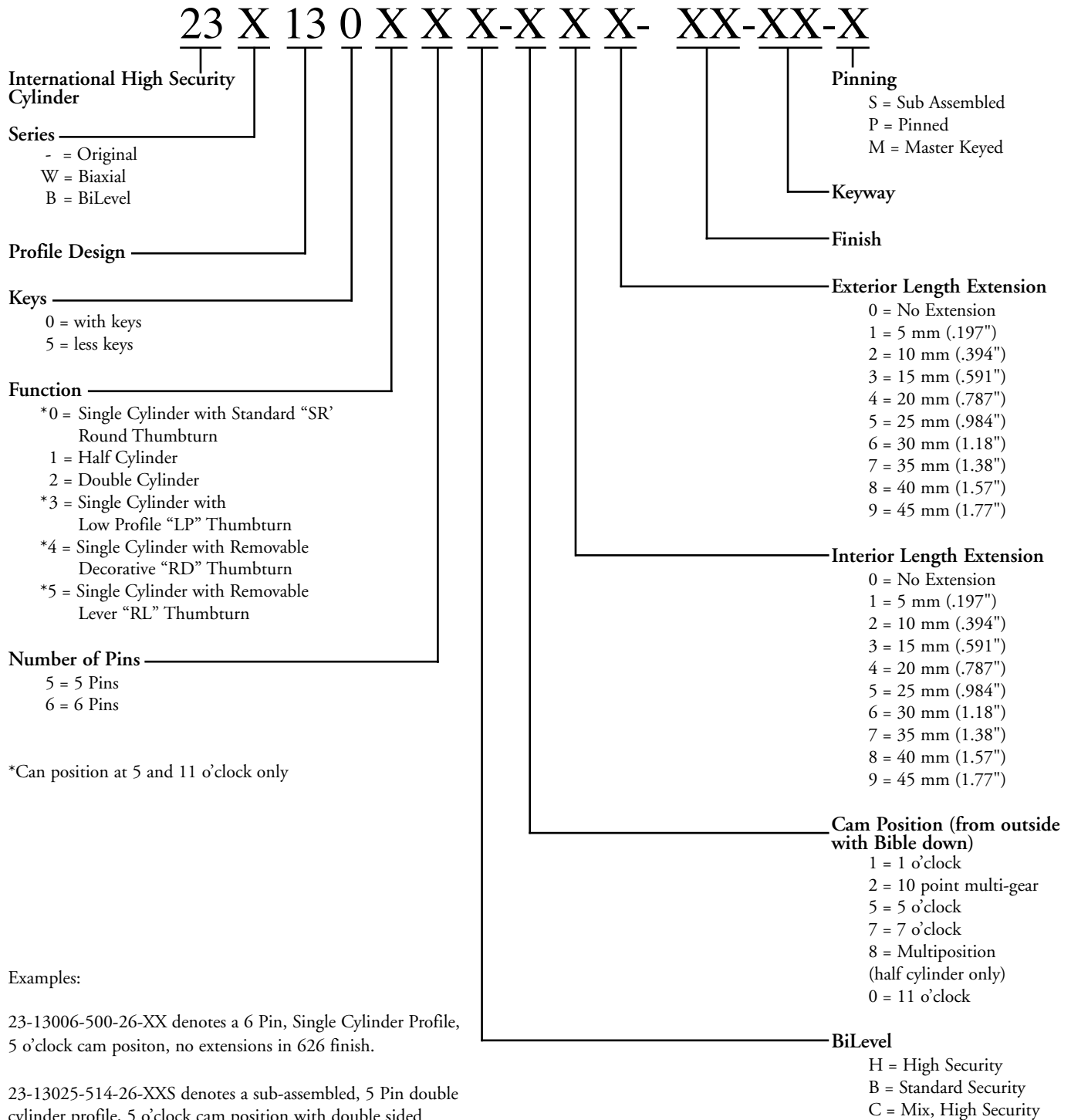

*Can position at 5 and 11 o'clock only

Other International Cylinders

Ordering Information

Complete part numbers are required for all orders. To determine the correct part number, fill in the "X's" in sequential order.

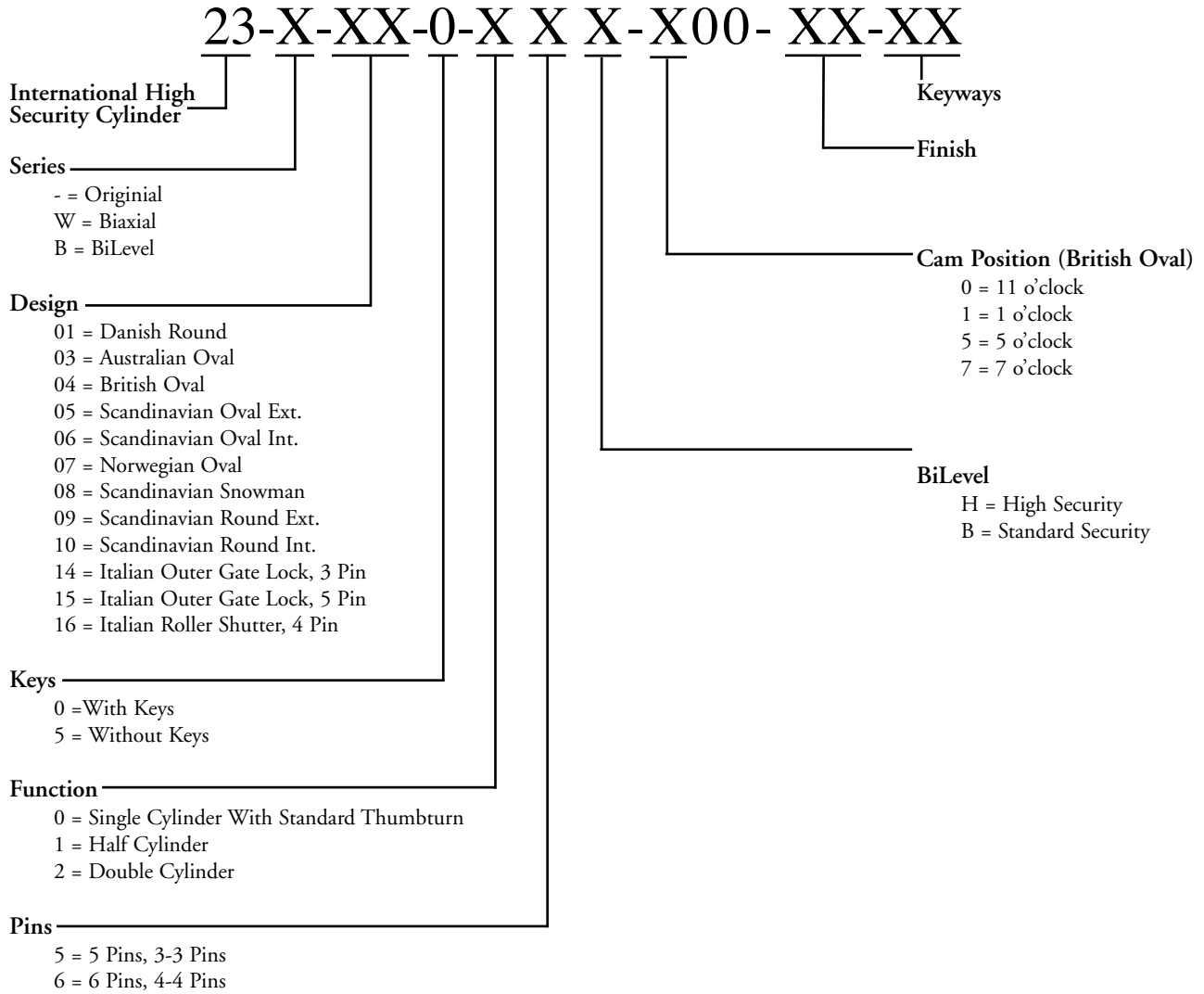

Exploded View

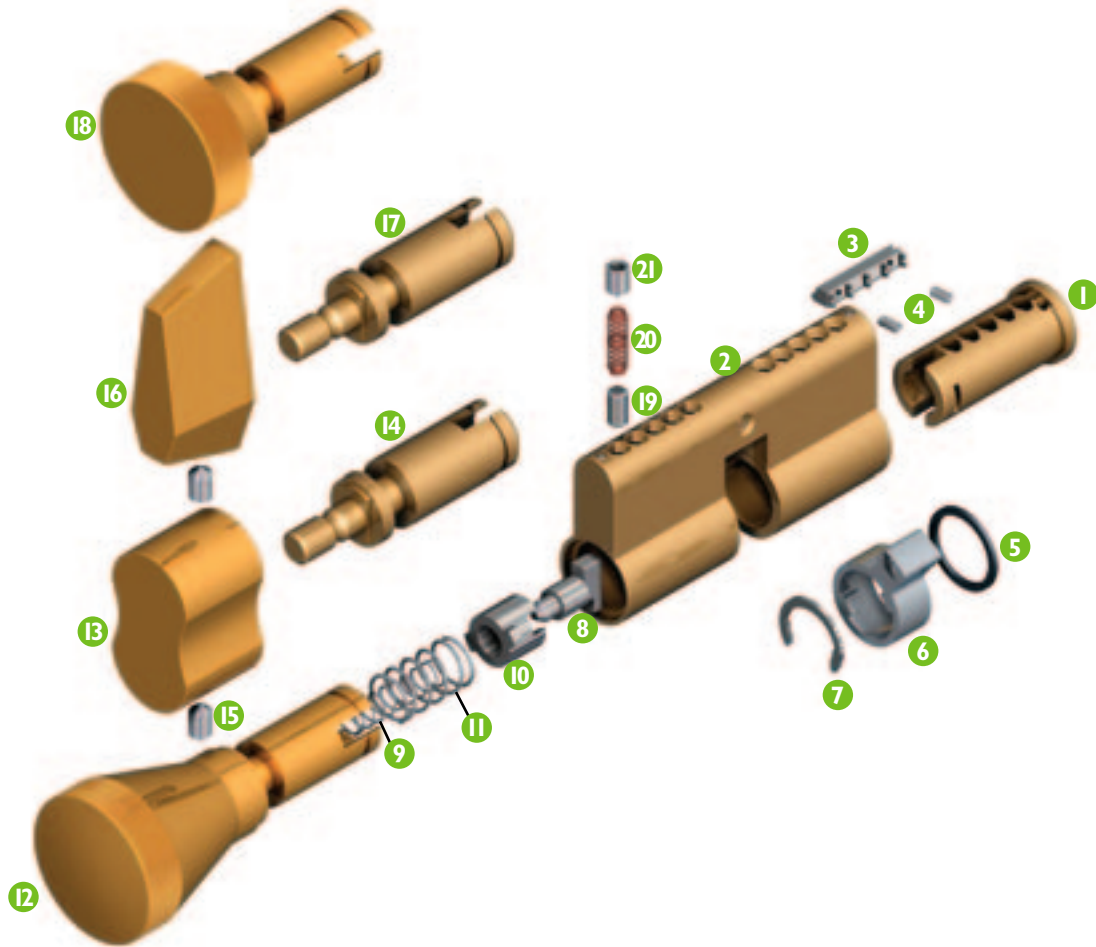

Item	Description	Part Number
1	Plug	Cylinder Specific
2	Shell	Cylinder Specific
3	Sidebar	Cylinder Specific
4	Sidebar Springs	CP-030018
5	Plug Retainer Ring	CP-021490
6	Cam	CT-Z51
7	Thumbturn Retaining Clip	CP-020031
8	Actuator	CP-100111
9	Actuator Spring	CP-030025
10	Actuator Pilot	CP-280261
11	Pilot Spring	CP-030024
12	Standard Round "SR" Thumbturn With Shaft - 5 Pin	CP-282001-XX
13	Removable Decorative "RD" Thumbturn	CP-284211-XX
14	Thumbturn Shaft - 5 Pin	CP-240481
15	Thumbturn Allen Set Screw #6-32 x 3/16" Knurled Cup Point	CP-012411-040
16	Removable Lever "RL" Thumbturn	CP-280401
17	Thumbturn Shaft - 5 Pin	CP-240481
18	Low Profile "LP" Thumbturn With Shaft	CP-284311-XX
19	Thumbturn Retaining Pin	TP-F10-1T
20	Thumbturn Retaining Pin Spring	CP-030001
21	Thumbturn Retaining Pin Allen Set Screw #8-32 x 1/4" Cone Point	CP-011013-040

Euro-Profile Cylinders

Single Cylinder with Thumbturn

TL = Total Length
B = Interior Length
C = Exterior Length

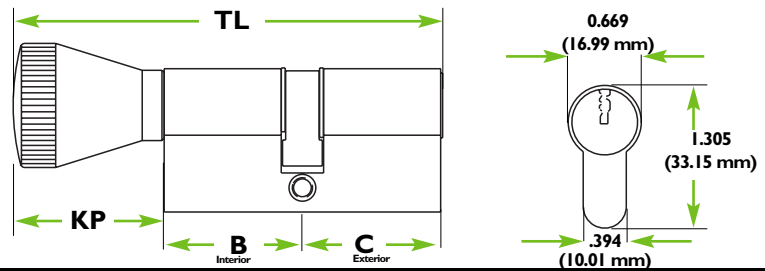

Description	Part #	TL	B	C	KP
5 Pin, Standard Round "SR" Thumbturn	23-13005-X00	99.04	31.98	31.98	35.08
5 Pin, Low Profile "LP" Thumbturn	23-13035-X00	81.44	31.98	31.98	17.48
5 Pin, Removable Decorative "RD" Thumbturn	23-13045-X00	83.09	31.98	31.98	19.13
5 Pin, Removable Lever "RL" Thumbturn	23-13055-X00	84.10	31.98	31.98	20.14
6 Pin, Standard Round "SR" Thumbturn	23-13006-X00	107.68	36.30	36.30	35.08
6 Pin, Low Profile "LP" Thumbturn	23-13036-X00	90.08	36.30	36.30	17.48
6 Pin, Removable Decorative "RD" Thumbturn	23-13046-X00	91.73	36.30	36.30	19.13
6 Pin, Removable Lever "RL" Thumbturn	23-13056-X00	92.74	36.30	36.30	20.14

* All table measurements in millimeters.

Double Cylinder

TL = Total Length
B = Interior Length
C = Exterior Length

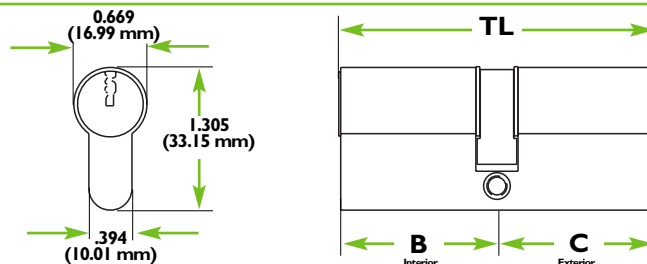

Description	Part #	TL	B	C
5 Pin, No Extension	23-13025-X00	63.96	31.98	31.98
6 Pin, No Extension	23-13026-X00	72.59	36.30	36.30
5 Pin Extended, 5 mm Ext. Side (0mm/5mm)	23-13025-X01	68.96	31.98	36.98
5 Pin Extended, 10 mm Ext. Side (0mm/5mm)	23-13025-X02	73.96	31.98	41.99
5 Pin Extended, (5mm/5mm)	23-13025-X11	73.96	36.98	36.98
5 Pin Extended, (5mm/10mm)	23-13025-X12	78.97	36.98	41.99
6 Pin Extended, 5 mm Ext. Side	23-13026-X01	77.60	36.30	41.30
6 Pin Extended, 10 mm Ext. Side	23-13026-X02	82.60	36.30	46.30
6 Pin Extended, (5mm/10mm)	23-13026-X12	87.60	41.30	46.30

* All table measurements in millimeters.

Euro-Profile Cylinders

Half Cylinder

TL = Total Length
B = Outside Length
C = Inside Length

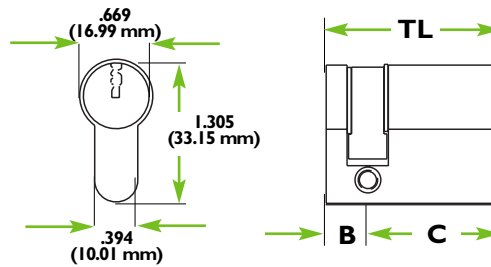

Description	Part #	TL	B	C
5 Pin with 12 Position Indexable Cam	23-13015-800	41.99	10.01	31.98
6 Pin with 12 Position Indexable Cam	23-13016-800	46.40	10.01	36.30
5 Pin, 5 mm Extension with 12 Position Indexable Cam	23-13015-801	46.99	10.01	36.98
6 Pin, 5 mm Extension with 12 Position Indexable Cam	23-13016-801	51.31	10.01	41.30

* All table measurements in millimeters.

Profile Parts

Part Number

5 Pin Plug For Half Cylinder	12-286XXX-XX
6 Pin Plug For Half Cylinder	12-288XXX-XX
5 Pin Double Cylinder Profile Plug	12-286XXX-XX-XX
6 Pin Double Cylinder Profile Plug	12-288XXX-XX-XX
5 Pin Shell For Half Cylinder	13-36500X
6 Pin Shell For Half Cylinder	13-37500X
5 Pin Double Cylinder Profile Shell	13-32700X-00
6 Pin Double Cylinder Profile Shell	13-34600X-00
Plug Retaining Ring For Half Cylinders	CP-021490
5 and 6 Pin Actuator For Half Cylinder	CP-220090
Actuator Spring For Half Cylinder	CP-030860
Single Cylinder Profile Pilot Spring	CP-030024
5 Pin Standard Round "SR" Thumbturn Assembly, No Extension	CP-282001-XX
6 Pin Standard Round "SR" Thumbturn Assembly, No Extension	CP-282101-XX
Single Cylinder Profile Thumbturn Actuator Pilot	CP-280261
Single Cylinder Profile Thumbturn Actuator Spring	CP-030025
Single Cylinder Profile Actuator	CP-100111
Tumbler Spring	CP-030001
Profile Cylinder Set Screw, #8-32 x 1/4"	CP-011013-040
Plug Retaining Clip - Continuous Ring	CP-021490
Plug Retaining Clip - Old Style, C Clip	CP-021400
5 Pin Low Profile "LP" Thumbturn Assembly	CP-284311-XX
6 Pin Low Profile "LP" Thumbturn Assembly	CP-284411-XX
Single Cylinder Profile Gear Cam	CP-230091
Double Cylinder Profile Gear Cam	CP-230081
5 Pin Removable Decorative "RD" Thumbturn Assembly, No Extension	CP-284801-XX
6 Pin Removable Decorative "RD" Thumbturn Assembly, No Extension	CP-2849X1-XX

Euro-Profile

Profile Parts	Part Number
Thumbturn Retaining Clip	CP-02003I
Removable Decorative "RD" Thumbturn Only	CP-2824I I-XX
Set Screw For Removable Thumbturn	CP-0124I I-040
5 Pin Removable Lever "RL" Thumbturn Assembly, No Extension	CP-28460I-XX
6 Pin Removable Lever "RL" Thumbturn Assembly, No Extension	CP-28470I-XX
Removable Lever "RL" Thumbturn Only	CP-28040I-XX
Double Cylinder Profile Clutch	CP-22007I
Single Thumbturn Cylinder Profile Cam, Non Indexing	CT-Z5I
Double Cylinder Profile Cam	CT-Z50
Indexing Cam For Half Cylinders	CT-Z88
Cam, British Oval (Half/Double)	CT-Z26
Cam, British Oval (Thumbturn)	CT-Z29

Euro Profiles

Single Cylinder with Thumbturn (Standard Length)

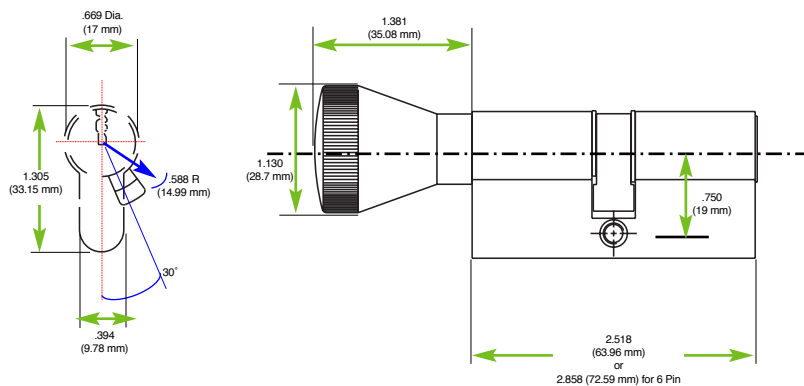

Part #: 23-13055-XXX-XX-XX 5 Pin
23-13056-XXX-XX-XX 6 Pin

Euro-Profile

Half Cylinder (Standard Length)

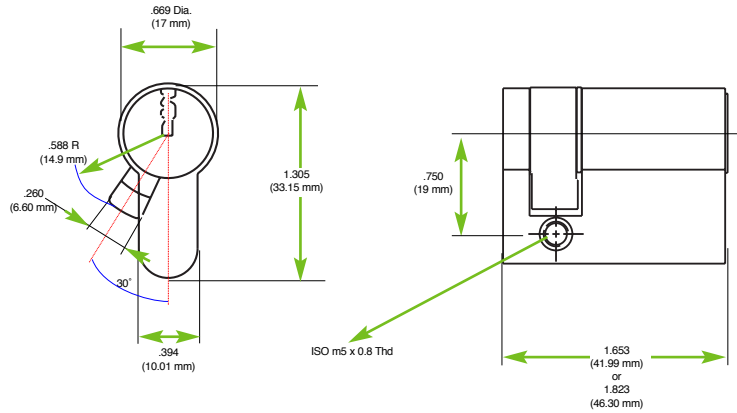

Cam position code as shown from outside.

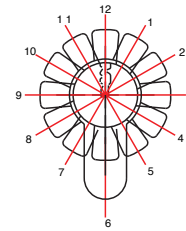

Multi-indexing cam with 12 positions. Cam is set at 5 o'clock from the factory

Part #: 23-I3015-800-XX-XX 5 Pin
23-I3016-800-XX-XX 6 Pin

Double Cylinder 5 Pin (Standard and Extended)

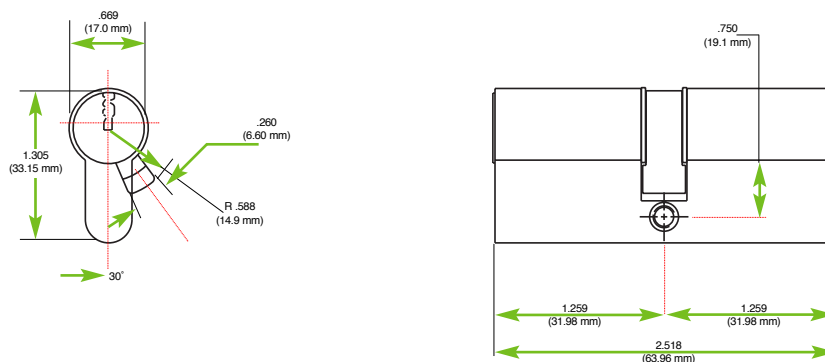

Cam position code as shown from outside.

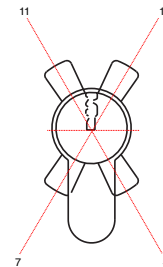

Standard: 23-I3025-X00-XX-XX 5 Pin
Extended: 23-I3025-X00-XX-XX 5 Pin

Double Cylinder 6 Pin (Standard and Extended)

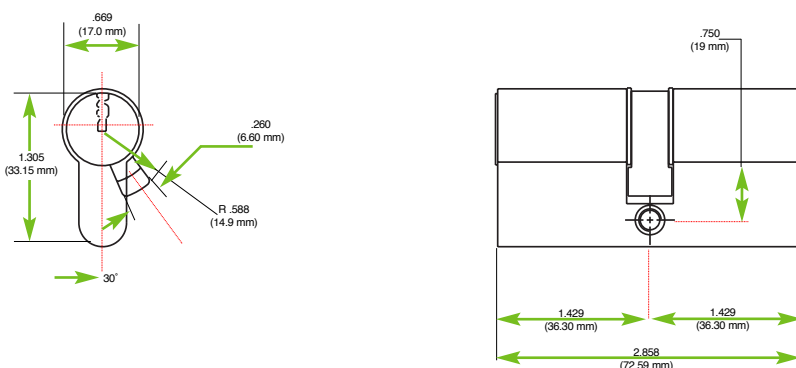

Cam position code as shown from outside.

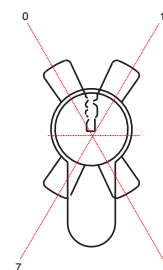

Standard: 23-I3026-X00-XX-XX 6 Pin
Extended: 23-I3026-X00-XX-XX 6 Pin

Other International Cylinders

Other International Cylinders

See the following drawings for more explanation

Description	Part #
Australian Oval - Less Cams and Pins	23X03016A
5 Pin British Oval Single Cylinder with Thumbturn	23X04005
6 Pin British Oval Single Cylinder with Thumbturn	23X04006
5 Pin British Oval Half Cylinder	23X04015
6 Pin British Oval Half Cylinder	23X04016
5 Pin British Oval Double Cylinder	23X04025
6 Pin British Oval Double Cylinder	23X04026
Danish Cam Lock (for Ruko®) w/ 90° Stop	23X20516
Danish Special Oval Cylinder Assembly	23X17016
Danish Round Mortise Cylinder	23X01016
Danish Special Cam Lock (Ruko®)	23X010168
Italian Cylinder Inner Gate Lock, 3 Pin	23X14003
Italian Cylinder Exterior Gate Lock, 5 Pin	23X15005
Italian Roller Shutter 4 Pin	23X16004
Norwegian Oval Shape Cylinder	23X070165
Scandinavian Oval Exterior Cylinder	23X05016
Scandinavian Oval Interior Cylinder	23X06016
Scandinavian Snowman Cylinder	23X080166
Scandinavian Round Exterior Cylinder	23X09016
Scandinavian Round Interior Cylinder	23X10016

Other International Cylinders

Union Single with Thumbturn

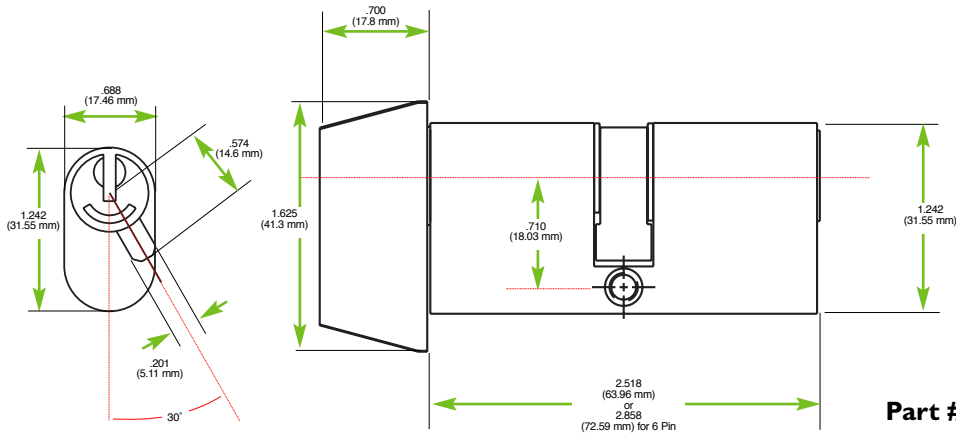

Cam position code as shown from outside.

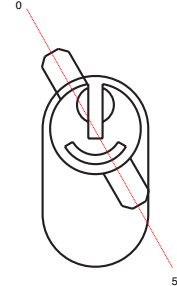

Part #: 23-04505-X-XX 5 Pin
23-04506-X-XX 6 Pin

Union Half Cylinder

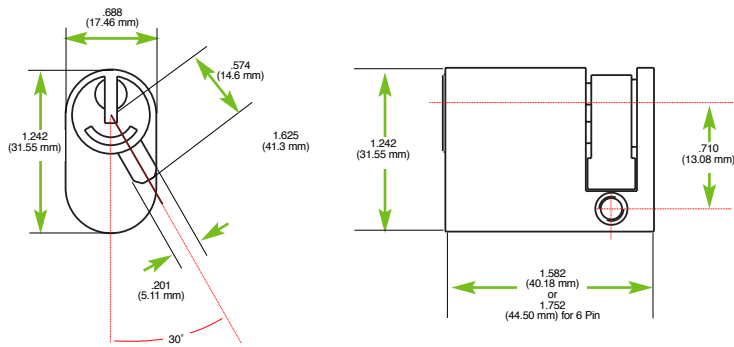

Cam position code as shown from outside.

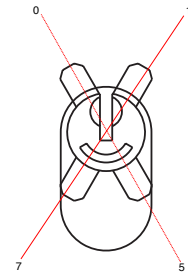

Part #: 23-04515-X-XX 5 Pin
23-04516-X-XX 6 Pin

Union Double Cylinder

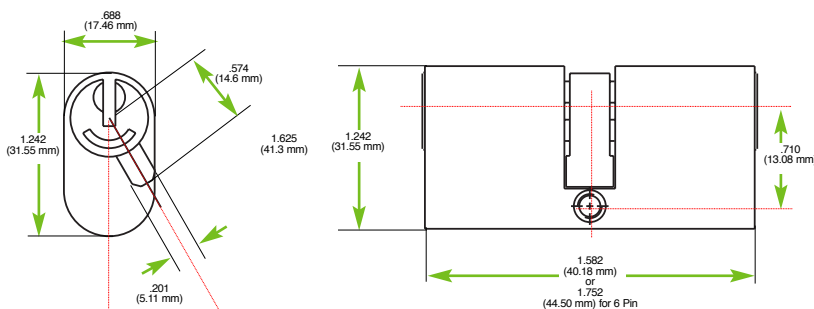

Cam position code as shown from outside.

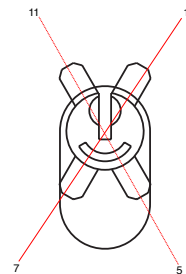

Part #: 23-04525-X-XX 5 Pin
23-04526-X-XX 6 Pin

Other International Cylinders

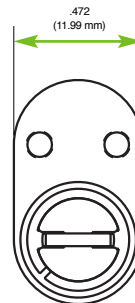
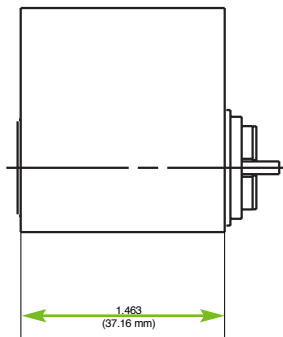
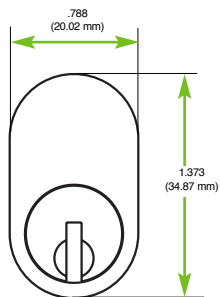

Tailpiece CT-Y76

Part #: 23-05516-XX 6 Pin

Scandinavian Oval - Interior for ASSA/Ruko®

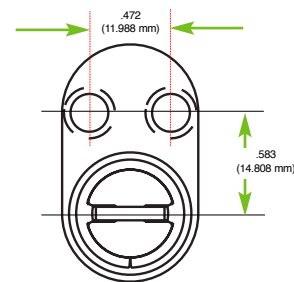
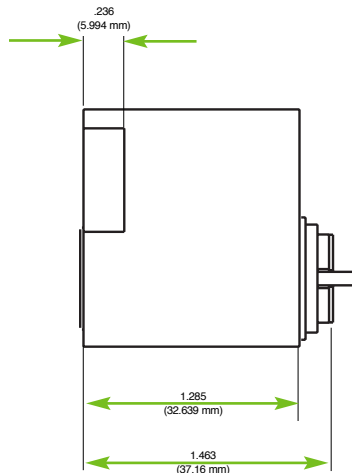
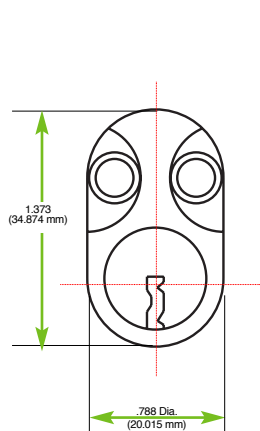

Tailpiece CT-Y76

Part #: 23-06516-XX 6 Pin

Scandinavian Padlock - for ASSA/Ruko®

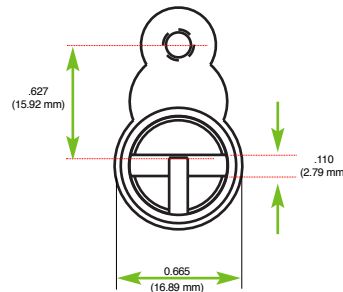
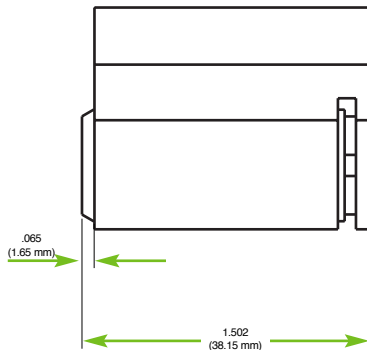
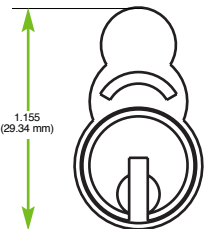

Part #: 23-08516X-XX 6 Pin

Other International Cylinders

Scandinavian Round Exterior - for ASSA/Ruko®

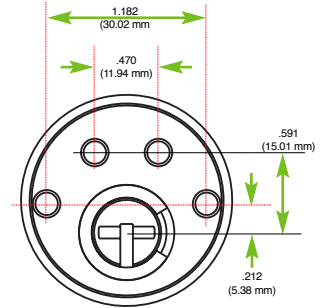
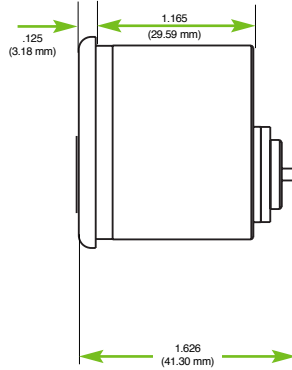
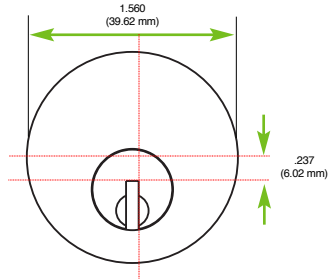

Part #: 23-09516X-XX 6 Pin

Scandinavian Round Interior - for ASSA/Ruko®

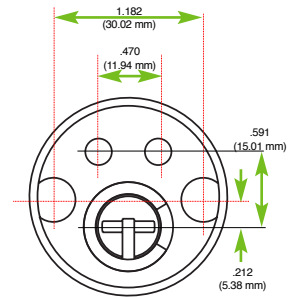
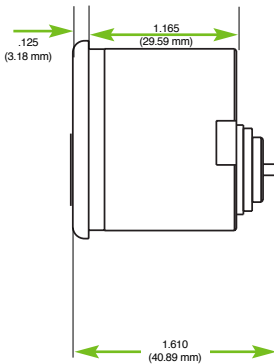
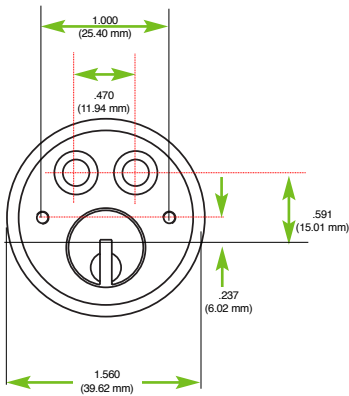

Part #: 23-10516-XX 6 Pin

Danish Round - Exterior for Ruko®

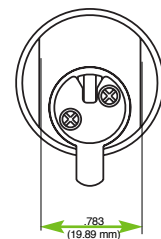
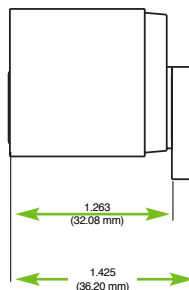
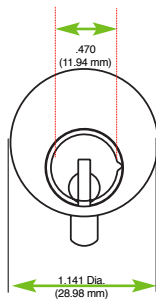

Part #: 23-01516-XX 6 Pin

Other International Cylinders

Norwegian Single Cylinder for Trio Ving®

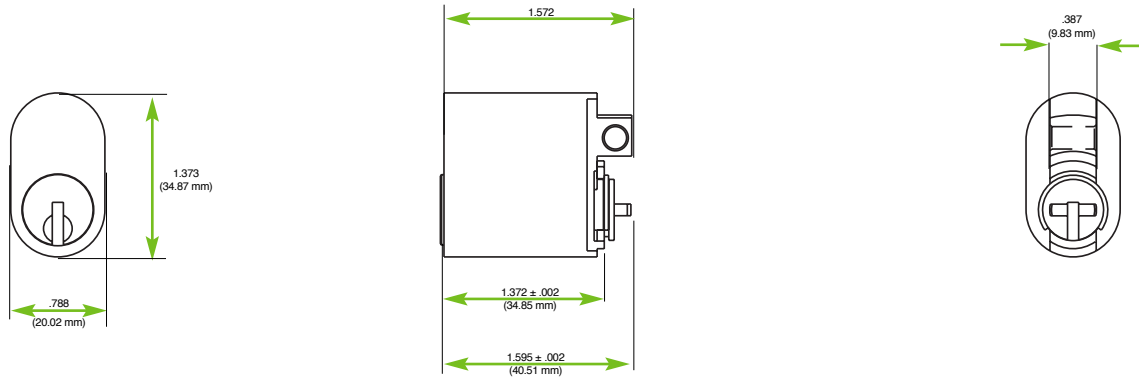

Part #: 23-075165-XX 6 Pin

Italian Inner Gate Lock Cylinder Assembly

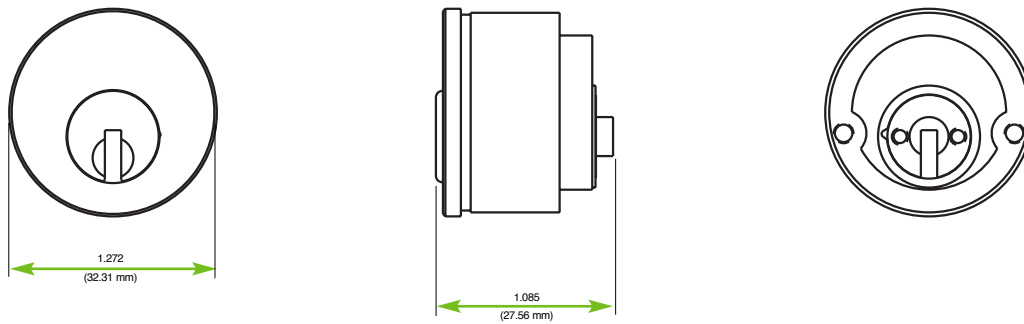

Part #: 23X14503-XX-XX 3 Pin

Italian Exterior Gate Lock Cylinder Assembly

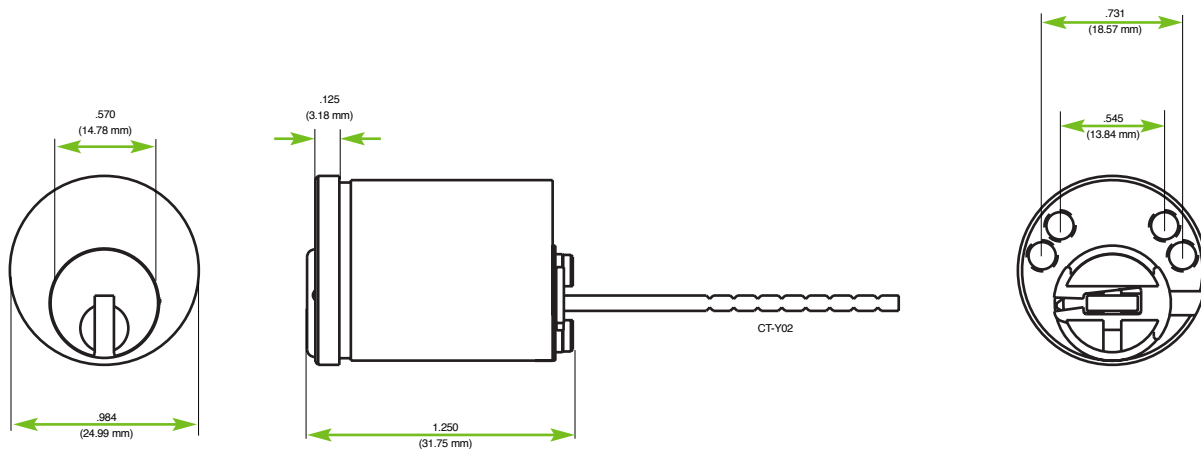

Part #: 23X15505-XX-XX 5 Pin

Other International Cylinders

Italian Roller Shutter Lock Cylinder Assembly

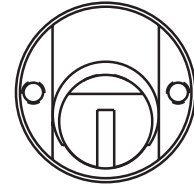
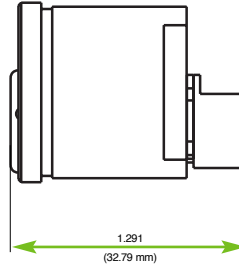
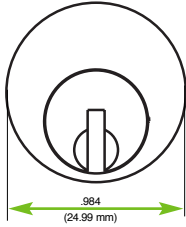

Part #: 23X16504-XX-XX 4 Pin