

# International

ASSA ABLOY, the global leader in door opening solutions

**medeco**  
HIGH SECURITY LOCKS  
**ASSA ABLOY**



## MEDECO TRULY LOCKS THE WORLD...

The Medeco reach extends to six continents. Medeco locks are used to protect facilities worldwide such as high security government installations, industrial and institutional organizations, airports, hotels, power plants, palaces, museums, universities and schools, and office buildings. Medeco's international cylinders are designed to fit in locksets of major world manufacturers. In addition to international

uses, many of these cylinders fit imported hardware used in North America. Because there are so many variations used around the world, we've limited the products in this printed catalog to the most common products. If you have a need for a cylinder, please call our International Sales department. It's quite likely that we'll have exactly what you need.

# International Cylinders



## FEATURES

MEDECO3

Utility patented key control provides protection from unauthorized duplication of keys in most countries



Superior master keying capability to accommodate systems of virtually any size



Other certifications provide validation of high security from recognized, independent testing laboratories



Triple locking principle provides pick resistance and large numbers of combinations for master keying flexibility to accommodate systems of virtually any size



Hardened steel inserts in the cylinder face provide proven drill resistance



Solid brass construction provides high quality and long cylinder life



Nickel plated pins provide exceptional wear resistance and additional hardened stainless steel pins provide drill resistance



European Profile Cylinders retrofit into virtually any manufacturers' locksets equivalent to DIN Standards



## Medeco<sup>3</sup>® Technical Information:

- ❖ UL437 Listing assures superior pick and drill resistance
- ❖ Pin chamber set screws provide ease of rekeying and resist comb attacks
- ❖ 5 and 6 Pin cylinders available

## Logic Technical Information

- ❖ 1,000 groups per cylinder/1,000 keys per group
- ❖ Audit either cylinder or key/up to 1,000 audit records (hardware dependant)
- ❖ 20,000 cycles battery life 2-level low battery indicator
- ❖ Multiple user access groups
- ❖ Uses proprietary CLIQ technology
- ❖ Available in all common cylinder formats including padlocks, cam locks, deadbolts, and cabinet locks
- ❖ Installs into standard hardware with no wiring or other modifications
- ❖ Reprogrammed with easy to use software and administration key

## Certification:

- ❖ SKG\*\*\*Netherlands
- ❖ Israeli Standards, I.S. 9950
- ❖ Swedish Standards SS3522
- ❖ EN1303
- ❖ DIN18254

## Warranty:

Warranted for two years against manufacturing defects. See Medeco Limited Warranty for full details.

## Medeco<sup>3</sup> Premium High Security

For effective mechanical protection against most forms of attack as well as protection against unauthorized duplicate keys, Medeco<sup>3</sup> cylinders are recommended. Security features including hardened steel components, pins that must be elevated, rotated, and interact with both a sidebar and a slider, and additional pick resistant features make Medeco<sup>3</sup> the cylinder of choice to protect people, property and information.

## Electronic Access Control

Euro half cylinders in this section are also available with Logic.

# How To Order International Cylinders - Euro-Profile

Here are the 4 things you need to know:

1. What's the base part number and technology?
  - 5 or 6 Pin
  - Thumbturn, double cylinder, or half cylinder
  - Cam position, length extensions (longer extensions available by special order)
2. What's the finish?
3. What keyway?
4. How do you want it pinned?

## BUILD A BASE PART #

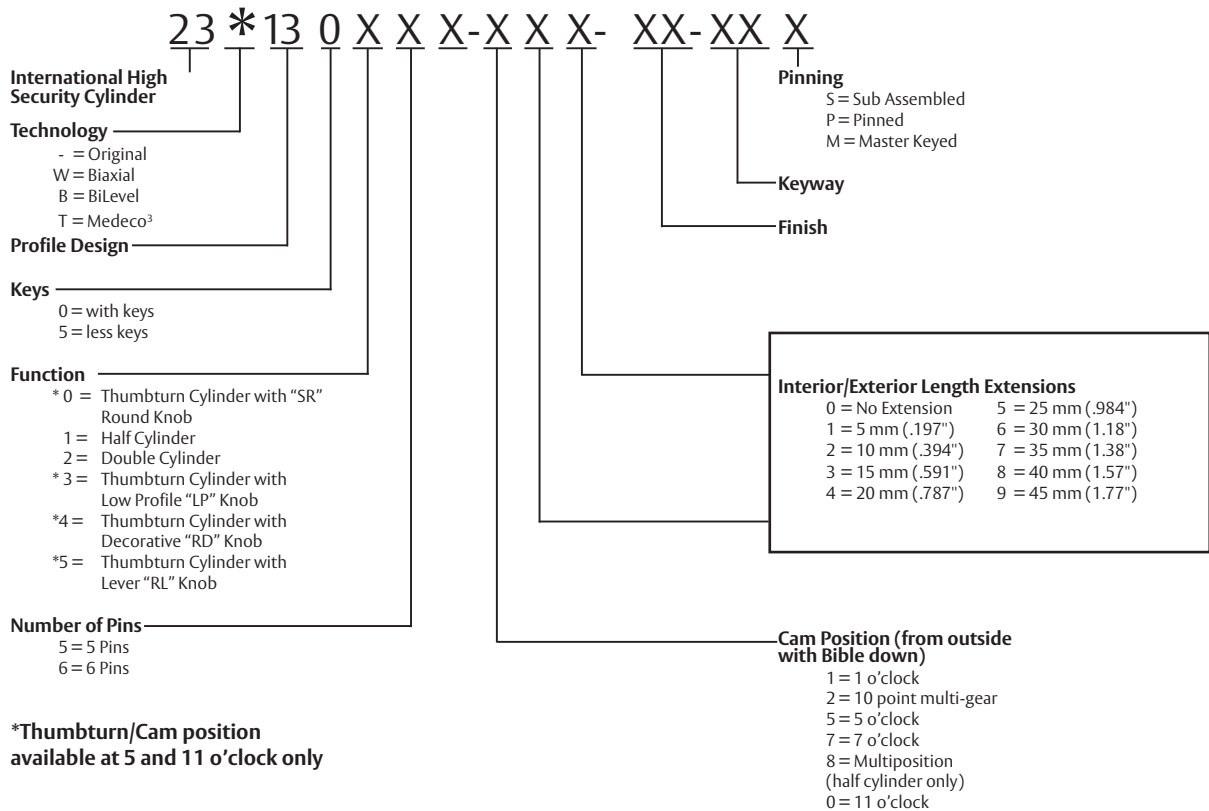

# How To Order Other International Cylinders

Complete part numbers are required for all orders. To determine the correct part number, fill in the "X's" in sequential order.

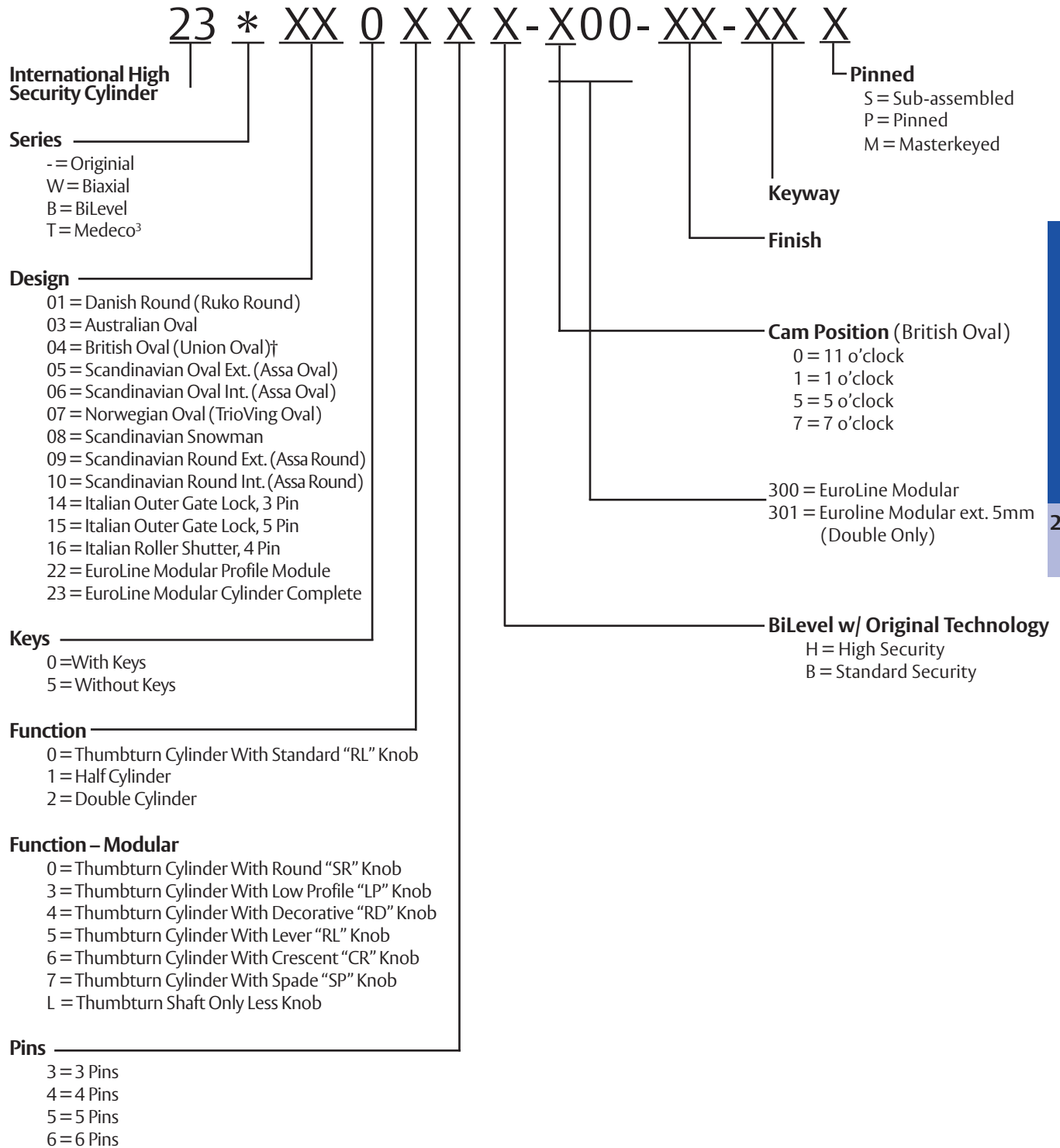

† Union Oval Thumbturn Position at 5 and 11 o'clock only

# EuroLine Modular Profile Cylinder System

The Medeco EuroLine product family is a modular cylinder system that allows the custom building of profile cylinders to meet the unique needs of the application. This system of modular cylinders, thumbturns and components are assembled to fit multiple lock functions, door thickness, and trim designs.

## All double cylinders are made up of:

Cylinder Modules (2)	Groove pins
Outer and inner plug extensions	Cam
Brass shell extension	Connecting bar & bar filler

## All single cylinder with thumbturn are made up of:

Cylinder Module (1) & Thumbturn Module (1)	Connecting bar & bar filler
Outer and inner plug extensions	Thumbturn actuator cartridge & cartridge extension
Brass shell extensions	Thumbturn, thumbturn shaft & set screw
Groove pins	Cam

## Modular Thumbturn Cylinder Assembled

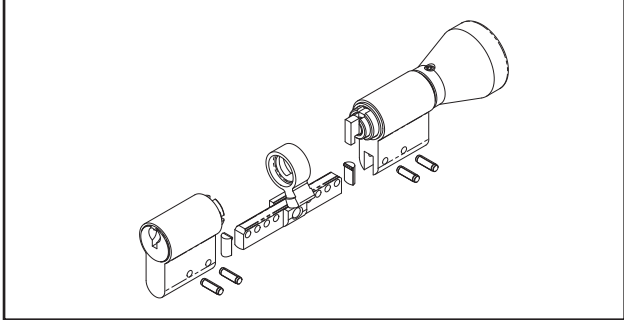

Description	Part Number
5 Pin Thumbturn/Cylinder	23*230X5-X00
6 Pin Thumbturn/Cylinder	23*230X6-X00

## Modular Cylinder Assembled

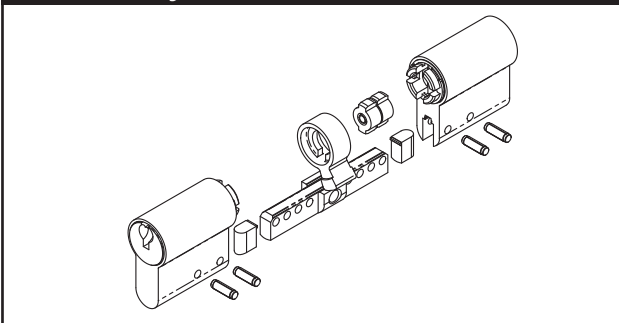

Description	Part Number
5 Pin Double Cylinder	23*23025-X00
6 Pin Double Cylinder	23*23026-X00

## Cylinder & Thumbturn Modules

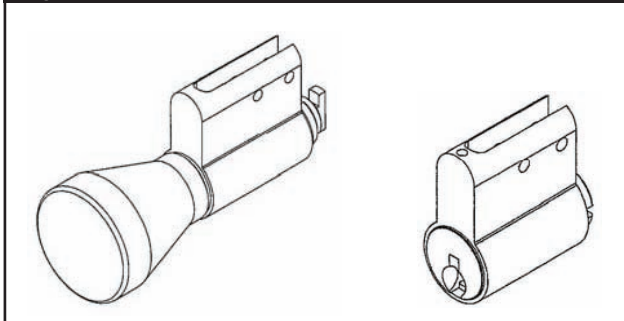

Description	Part Number
5 Pin Cylinder	23*22015-300
5 Pin Cylinder + 5mm	23*22015-301
6 Pin Cylinder	23*22016-300
6 Pin Cylinder + 5mm	23*22016-301
5 Pin Thumbturn	23*22005-500
6 Pin Thumbturn	23*22006-500

## Euroline Modular Profile Kit

Description	Part Number
Euroline Modular Profile Kit (individual parts list below)	94-0219

### Components of Modular and Kit Quantities

#### Plug Extensions – Outer

	Description	Part Number	Kit Qty
	5mm	CP-200751-05	N/A
	10mm	CP-200751-10	20
	15mm	CP-200751-15	10
	20mm	CP-200751-20	5
	25mm	CP-200751-25	5

#### Plug Extensions – Inner

	Description	Part Number	Kit Qty
	5mm	CP-200761-05	20
	10mm	CP-200761-10	20
	15mm	CP-200761-15	10
	20mm	CP-200761-20	5
	25mm	CP-200761-25	5

#### Brass Shell Extensions

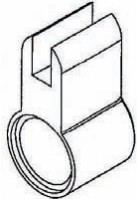
	Description	Part Number	Kit Qty
	5mm	CP-200771-05	20
	10mm	CP-200771-10	20
	15mm	CP-200771-15	10
	20mm	CP-200771-20	5
	25mm	CP-200771-25	5

#### Bar Filler (2 per cylinder)

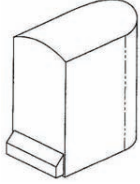
	Description	Part Number	Kit Qty
	5 Pin - 0mm	CP-160661-50	35
	5 Pin - 5mm	CP-160661-55	35
	6 Pin - 0mm	CP-160661-60	35
	6 Pin - 5mm	CP-160661-65	35

#### Thumbturn Actuator Cartridge

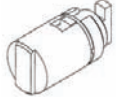
	Description	Part Number	Kit Qty
	Cartridge	CP-220131	2

#### Thumbturn Cartridge Extensions

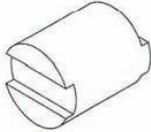
	Description	Part Number	Kit Qty
	5mm	CP-200781-05	10
	10mm	CP-200781-10	10
	15mm	CP-200781-15	5
	20mm	CP-200781-20	5
	25mm	CP-200781-25	5

## Connecting Bar

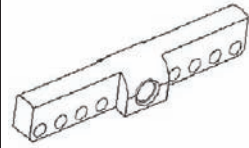

Description	Part Number	Kit Qty
5mm	CP-200801-00	15
10mm	CP-200801-02	5
20mm	CP-200801-04	5
30mm	CP-200801-06	5
40mm	CP-200801-08	1
50mm	CP-200801-0A	1
10/10mm	CP-200801-22	5
10/20mm	CP-200801-24	5
10/30mm	CP-200801-26	3
10/40mm	CP-200801-28	1
10/50mm	CP-200801-2A	1
20/20mm	CP-200801-44	3
20/30mm	CP-200801-46	1
20/40mm	CP-200801-48	1
20/50mm	CP-200801-4A	1
30/30mm	CP-200801-66	1
30/40mm	CP-200801-68	1
30/50mm	CP-200801-6A	1
40/40mm	CP-200801-88	1
40/50mm	CP-200801-8A	1
50/50mm	CP-200801-AA	1

## Thumbturn Shaft

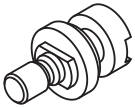

Description	Part Number	Kit Qty
5 Pin	CP-240771-5P-XX	2
6 Pin	CP-270771-6P-XX	2

## Modular Service Tools

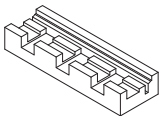

94-0208

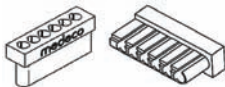

94-0203

Description	Part Number	Kit Qty
Modular Assembly Block	94-0208	1
Pinning Block	94-0203	2
Capping Tool	94-0207	2
Removing Punch, 2.3 mm	94-0222	1
Installing punch, 6.35 mm	94-0223	1
Allen Wrench, 1.588 mm	CP-280330	1
Small flat blade screwdriver	94-0221	1





## Miscellaneous Components

 CP-170730-(5 or 6)	Description	Part Number	Kit Qty
	Groove Pin	CP-063220	200
	Clutch Piece Assembly	CP-220071	20
	5 Pin Cover	CP-170730-5	50
	6 Pin Cover	CP-170730-6	50
	Thumbturn Cam	CT-Z51	20
	Double Cam	CT-Z50	20
	Thumbturn Set Screw	CP-011013-020	—
	Snap Ring	CP-031030	—
	Cartridge Retainer	CP-020240	—
	Emergency Cam	CT-Z89	—
	Thumbturn Cylinder Gear	CP-230091	—
	Double Cylinder Gear	CP-230081	—
Thumbturn Set Screw	CP-012411-030	—	

## Top Pins

Part Number	Length	Kit Qty
TP-F10-4T (.180")	1	200
TP-F10-5T (.150")	2	200
TP-H10-9W (.135")	3	200
TP-F10-4W-6T (.120")	4	200
TP-F10-3W (.090")	5	200
TP-F10-2W (.060")	6	200

## Thumbturn Knobs

 "LP"	 "RL"	 "RD"	Description	Part Number
			Low Profile "LP"	CP-285991-XX
			Lever "RL"	CP-285931-XX
			Decorative "RD"	CP-285901-XX
			Round "SR"	CP-285961-XX
			Crescent "CR"	CP-286021-XX
			Spade "SD"	CP-286051-XX

### Thumbturn Extension Kits – Plugs & Shells Includes 1 each of shell extension & thumbturn cartridge extension

Description	Part Number
5mm	94-0206-T05
10mm	94-0206-T10
15mm	94-0206-T15
20mm	94-0206-T20
25mm	94-0206-T25
30mm	94-0206-T30
35mm	94-0206-T35
40mm	94-0206-T40
45mm	94-0206-T45
50mm	94-0206-T50
55mm	94-0206-T55

### Cylinder Extension Kits – Plugs & Shells Includes 1 each of shell extension & thumbturn cartridge extension

Description	Part Number
5mm	94-0206-C05
10mm	94-0206-C10
15mm	94-0206-C15
20mm	94-0206-C20
25mm	94-0206-C25
30mm	94-0206-C30
35mm	94-0206-C35
40mm	94-0206-C40
45mm	94-0206-C45
50mm	94-0206-C50
55mm	94-0206-C55



## Euro Profile Single Cylinder with Thumbturn

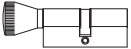
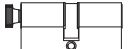
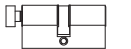
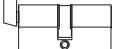
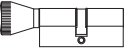
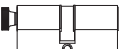
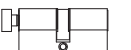
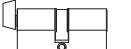
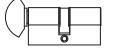
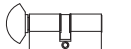

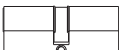

Description	Part Number
 5 Pin, Standard Round "SR" Knob	23*13005-X00
 5 Pin, Low Profile "LP" Knob	23*13035-X00
 5 Pin, Removable Decorative "RD" Knob	23*13045-X00
 5 Pin, Removable Lever "RL" Knob	23*13055-X00
 6 Pin, Standard Round "SR" Knob	23*13006-X00
 6 Pin, Low Profile "LP" Knob	23*13036-X00
 6 Pin, Removable Decorative "RD" Knob	23*13046-X00
 6 Pin, Removable Lever "RL" Knob	23*13056-X00
 5 Pin, Euro Crescent Knob "CR"	49*0264
 6 Pin, Euro Crescent Knob "CR"	49*0291

## Euro Profile Double Cylinder

Description	Part Number
 5 Pin, No Extension	23*13025-X00
 6 Pin, No Extension	23*13026-X00
 5 Pin Extended, 5 mm Ext. Side (0mm/5mm)	23*13025-X01
 5 Pin Extended, 10 mm Ext. Side (0mm/10mm)	23*13025-X02
 5 Pin Extended, (5mm/5mm)	23*13025-X11
 5 Pin Extended, (5mm/10mm)	23*13025-X12
 6 Pin Extended, 5 mm Ext. Side (0mm \ 5mm)	23*13026-X01
 6 Pin Extended, 10 mm Ext. Side (0mm \ 10mm)	23*13026-X02
 6 Pin Extended, (5mm/10mm)	23*13026-X12

\* in part number is replaced with: T = Medeco<sup>3</sup>, J = BiLevel, W = Biaxial, K = KeyMark, or "-" = Original  
N = KeyMark x4, C = Logic

## Euro Profile Half Cylinder

Description	Part Number
 5 Pin with 12 Position Indexable Cam	23*13015-800
 6 Pin with 12 Position Indexable Cam	23*13016-800
 5 Pin, 5 mm Extension with 12 Position Indexable Cam	23*13015-801
 6 Pin, 5 mm Extension with 12 Position Indexable Cam	23*13016-801

## Other International Cylinders

Description	Part Number
Australian Oval - Less Cams and Pins	23*03016A
5 Pin British Oval Single Cylinder with Thumbturn	23*04005
6 Pin British Oval Single Cylinder with Thumbturn	23*04006
5 Pin British Oval Half Cylinder	23*04015
6 Pin British Oval Half Cylinder	23*04016
5 Pin British Oval Double Cylinder	23*04025
6 Pin British Oval Double Cylinder	23*04026
Danish Cam Lock (for Ruko®) w/ 90° Stop	23*20016
Danish Special Oval Cylinder Assembly	23*17016
Danish Round Mortise Cylinder	23*01016
Danish Special Cam Lock (Ruko®)	23*010168
Italian Cylinder Inner Gate Lock, 3 Pin	23*14003
Italian Cylinder Exterior Gate Lock, 5 Pin	23*15005
Italian Roller Shutter 4 Pin	23*16004
Norwegian Oval Shape Cylinder	23*070165
Scandinavian Oval Exterior Cylinder	23*05016
Scandinavian Oval Interior Cylinder	23*06016
Scandinavian Snowman Cylinder	23*080166
Scandinavian Round Exterior Cylinder	23*09016
Scandinavian Round Interior Cylinder	23*10016

## Profile Components

Description	Part Number
5 Pin Plug For Double Cylinder	12-286XXX-XX
6 Pin Plug For Half Cylinder	12-288XXX-XX
5 Pin Double Cylinder Profile Plug	12-286XXX-XX-XX
6 Pin Double Cylinder Profile Plug	12-288XXX-XX-XX
5 Pin Shell For Half Cylinder	13-36500X
6 Pin Shell For Half Cylinder	13-37500X
5 Pin Double Cylinder Profile Shell	13-32700X-00
6 Pin Double Cylinder Profile Shell	13-34600X-00
Plug Retaining Ring For Double and Half Cylinders	CP-021490
5 or 6 Pin Actuator For Half Cylinder	CP-220090
Actuator Spring For Half Cylinder	CP-030860
Single Cylinder Profile Pilot Spring	CP-030024
Standard Round "SR" Thumbturn Assembly 5 Pin	CP-282001-FN
Single Cylinder Profile Thumbturn Actuator Pilot	CP-280261
Single Cylinder Profile Thumbturn Actuator Pilot Spring	CP-030025
Single Cylinder Key Actuator For Profile	CP-100111
Tumbler Spring	CP-030001
Profile Cylinder Set Screw, #8-32 x 1/4"	CP-011013-040
Plug Retaining Clip - Continuous Ring	CP-021490
Plug Retaining Clip - Old Style, C Clip	CP-021400
Low Profile "LP" Thumbturn Assembly 5 Pin	CP-284311-FN
Decorative "RD" Thumbturn Assembly 5 Pin	CP-284801-FN
Crescent "CR" Thumbturn Assembly 5 Pin	CP-286041-FN
Thumbturn Retaining Clip	CP-020031
Set Screw For Removable Thumbturn	CP-012411-040
Lever "RL" Thumbturn Assembly	CP-284601-FN
Cam, British Oval (Half/Double)	CT-Z26
Cam, British Oval (Thumbturn)	CT-Z29
Clutch Assembly, Emergency	CP-220120

\* Medeco<sup>3</sup> plugs not sold with slider & spring

## Profile Components

Description	Part Number
Set Screw for "CR" Thumbturn	CP-012409-030
Indexing Cam For Half Cylinders	CT-Z88
Double Cylinder Profile Gear Cam	CP-230081
Thumbturn Cylinder Profile Gear Cam	CP-230091
Oval Int./Ext. Cylinder tailpiece	CT-Y76

\* Medeco<sup>3</sup> plugs not sold with slider & spring